

## DATA SHEET

### MODULETEK: GPON-OLT-CP-X-C10

SFP GPON OLT Transceiver Class C+ 2488/1244Mbps with DOM

### GPON-OLT-CP-X-C10 Overview

ModuleTek's GPON-OLT-CP-X-C10 is a point-to-multipoint (P2MP) high quality EPON transceiver module, mainly used in home, Business or Curb (FTTX). It is designed for 2488 Mbps downstream and 1244 Mbps upstream duplex data link transmission, high-speed burst mode TDM receiver/transmitter is used. It is based on the ITU-T G.984.2 B+ class specification, and for two-way communication on a single fiber, with high bandwidth, high efficiency, large coverage, rich user interface and many other advantages, and integrates a high-performance 1310nm burst mode APD/TIA receiver and 1490nm continuous mode DFB transmitter with internal optical isolator.

### Product Features

- Single fiber bi-directional data links with 2488Mbps Tx and 1244Mbps Rx
- 1310nm APD/TIA burst-mode Receiver
- 1490nm continuous-mode DFB Laser with Isolator
- ITU-T G.984.2 Compliant
- SFF-8472 Compliant
- Low Power Consumption
- Hot-pluggable SFP footprint
- Simplex SC connector
- Single power supply 3.3V
- RoHS Compliant
- Class 1 laser product complies with EN 60825-1
- Operating temperature range:
  - Level C: 0°C to 70°C
  - Level I: -40°C to 85°C



### Applications

- Access Networks
- Fiber to the Home, Curb, Office (FTTX)
- Point to Multi Point Service (P2MP)
- FSAN Class C+

## Ordering Information

Part Number	Product ID	Description
GPON-OLT-CP-C-C10	M398500	SFP GPON OLT Transceiver Class C+ 2488/1244Mbps with DOM, Commercial temperature
GPON-OLT-CP-I-C10	M398501	SFP GPON OLT Transceiver Class C+ 2488/1244Mbps with DOM, Industrial temperature
<b>For More Information:</b> ModuleTek Limited Web: <a href="http://www.moduletek.com">www.moduletek.com</a> Email: <a href="mailto:sales@moduletek.com">sales@moduletek.com</a>		

## General Specifications

Parameter	Symbol	Min	Typ	Max	Unit	Remarks
Data Rate	DR		2488/1244		Mb/s	1
Bit Error Rate	BER			$10^{-10}$		
Operating Temperature	$T_C$	-0		70	°C	2
		-40		85	°C	2
Storage Temperature	$T_{STO}$	-40		85	°C	3
Supply Current	$I_{CC}$		200	300	mA	4
Input Voltage	$V_{CC}$	3.14	3.3	3.46	V	
Maximum Voltage	$V_{MAX}$	-0.5		4	V	4

### Notes:

1. Downstream/Upstream
2. Case temperature
3. Ambient temperature
4. For electrical power interface

## Optical – Characteristics – Transmitter

Parameter	Symbol	Min	Typ	Max	Unit	Remarks
Transmitter Type	1490nm DFB Laser with Isolator					1
Downstream Signaling Speed	$S_{TX}$		2488		Mb/s	
Output Optical Power	$P_{TX}$	3		7	dBm	2
Optical Center Wavelength	$\lambda_C$	1480		1500	nm	
Extinction Ratio	ER	8.2			dB	
Spectral Width (-20dB)	$\Delta\lambda$			1	nm	
Side Mode Suppression Ratio	SMSR	30			dB	
Launch Power of OFF Transmitter	$P_{OUT\_OFF}$			-40	dBm	
Output Eye	Compliant with G.984. 2		Data Rate=2488Mb/s			

**Notes:**

1. Continuous-mode
2. Class 1 Product

### Typical eye diagram

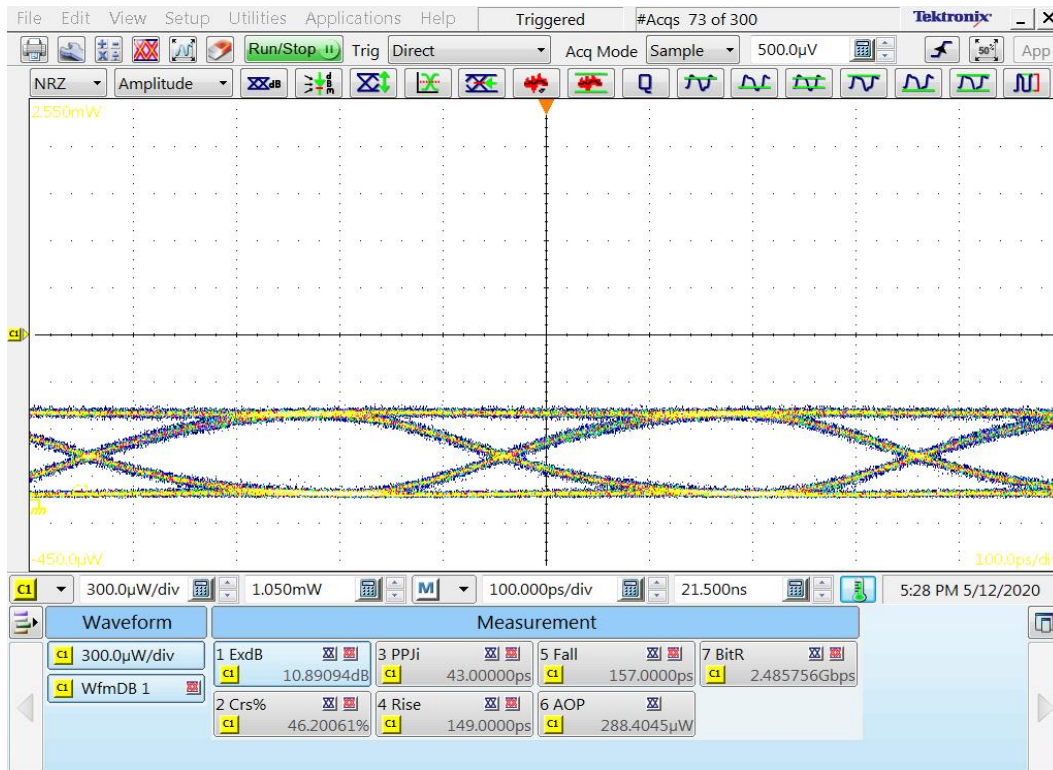

## Optical – Characteristics – Receiver

Parameter	Symbol	Min	Typ	Max	Unit	Remarks
Receiver Type	1310nm APD/TIA burst-mode Receiver					
Signaling Speed	$S_{rx}$		1244		Mb/s	
Optical Center Wavelength	$\lambda_c$	1280	1310	1360	nm	
Average Rx Sensitivity @ 1244Mb/s	$R_{X\_SEN}$			-30	dBm	1
Burst Sensitivity Receiver Overload	$P_{MAX}$	-12			dBm	
Receiver Burst Mode Dynamic Range		15			dB	
LOS Assert	$LOS_A$	-45			dBm	
LOS De-Assert	$LOS_D$			-32	dBm	
LOS Hysteresis	$LOS_H$	0.5			dB	

### Notes:

1.@BER  $10^{-10}$  PRBS  $2^{23}-1$

## Electrical Characteristics

Parameter	Symbol	Min	Typ	Max	Unit	Remarks
Input differential impedance	$R_{IN}$		100		$\Omega$	
Differential data input swing	$V_{IN\_PP}$	600		1600	mV	
Differential data output swing	$V_{OUT\_PP}$	400		1600	mV	
Input Signal Level (LVTTTL H)	V	2.0		$V_{CC}$	V	
Input Signal Level (LVTTTL L)	V	0		0.8	V	
Output Signal Level (LVTTTL H)	V	2.4		$V_{CC}$	V	
Output Signal Level (LVTTTL L)	V	0		0.4	V	

## A0/A2 Write Protection

Security Level 1 Password		
Password Entry ADDR	Size	Vaules(hex)
Page A2,7BH-7EH	4	00 00 00 00

This module has the A0 / A2 write protection function. The user can enter the security level 1 working state and write the contents of Table 00 and Table 01 of the device address A0H and A2H of the module. The method to enter the working state of security level 1 is to write the security level 1 password in order in the 7BH-7EH registers of A2H of the module. After entering security level 1, the user can directly write to the contents of the A0H device address, or modify the contents of the A2H 7F table selection register to write to the contents of Table 00 or Table 01. This version of the module does not support users to modify the password of security level 1. If you need to modify the security level 1 password, you must notify our company to modify it before shipping.

## I2C Memory Map(Page A0 HEX,Unlisted Fields are Blank/Empty)

IIC ADDR	Size	Name	Description	Vaules(HEX)
0	1	Identifier	SFP	03
1	1	Extended Identifier	Extended Identifier	04
2	1	Connector	Connector Type=SC	01
3-10	8	Transceiver	Code for electronic or optical compatibility	00 00 00 00 00 00 00 00
11	1	Encoding	Code for high speed serial encoding algorithm	03
12	1	BR,Nominal	Nominal Bit Rate 2.5Gb/s	19
13	1	Rate Identifier	Type of rate select functionality	00
14	1	Lenth(9μm)-km	20km Link Length in Thousands of Meters / SMF	14
15	1	Lenth(9μm)-100m	9-micron MMF Link Length	C8
16	1	Lenth(50μm)-10m	50-micron MMF Link Length = N/A	00
17	1	Lenth(62.5μm)-10m	62.5-micron MMF Link Length = N/A	00
18	1	Lenth(Copper)	Copper Link Length = N/A	00
19	1	Reserved	Reserved	00
20-35	16	Vendor name	ModuleTek	ASCII Format
36	1	Transceiver	Code for electronic or optical compatibility	00

37-39	3	Vendor OUI	SFP Vendor IEEE Company ID	ASCII Format
40-55	16	Vendor PN	The Part number in the Ordering Information	ASCII Format
56-59	4	Vendor Revision Number	Vendor Revision Number	Programmed by Factory
60-61	2	Wavelength	Wavelength	according to actual wavelength
62	1	Reserved	Reserved	00
63	1	CC_BASE	Check sum of bytes 0-62	Programmed by Factory
64-65	2	Transceiver Options	1.Rx_LOS 2.Tx_FAULT 3.Tx_DIS	00 1C
66	1	BR, max	Upper bit rate margin	00
67	1	BR, min	Lower bit rate margin	00
68-83	16	Vendor SN	Vendor SN	Programmed by Factory
84-91	8	Date code	Year,Month,Day	Programmed by Factory
92	1	Monitoring Type	Internally Calibrated Received power measurement type-Average Power	68
93	1	Enhanced Options	1. Optional Alarm/Warning Flags Implemented 2. Soft Rx_LOS Monitor 3.Soft Tx_FAULT Monitor	B0
94	1	SFF-8472 Compliance	Indicates which revision of SFF-8472 the transceiver complies with	08
95	1	CC_EXT	Check sum of bytes 64-94	Programmed by Factory
96-127	32	Vendor Specific	Vendor Specific EEPROM	Programmed by Factory
128-255	128	Vendor Specific	Vendor Specific	Programmed by Factory

## Digital Diagnostic Functions

GPON-OLT-CP-X-C10 supports the 2-wire serial communication protocol as defined in SFP MSA. Digital diagnostic information is accessible over the 2-wire interface at the address 0xA2. Digital diagnostics for GPON-OLT-CP-X-C10 are internally calibrated by default. The internal micro control unit accesses the device operating parameters in real time, Such as transceiver temperature, laser bias current, transmitted optical power, received optical power and transceiver supply voltage. The module implements the alarm function of the SFP MSA, alerts the user when a particular operating parameter exceeds the factory-set normal range.

Digital Diagnostic Threshold Range					
Parameter		High Alarm(hex)	High Warning(hex)	Low Warning(hex)	Low Alarm(hex)
Temperature (°C)	C	75 (4B 00)	70 (46 00)	0(00 00)	-5 (FB 00)
	I	90 (0x5A00)	85 (0x5500)	-40 (0xD800)	-45 (0xD300)
Voltage (V)		3.63 (0x8DCC)	3.46 (0x8728)	3.13 (0x7A44)	2.97 (0x7404)
Bias Current (mA)		90 (0xAFC8)	70 (0x88B8)	4 (0x07D4)	2 (0x03E8)
Tx Power (µW)		6014.2(0xEAE E)	5012 (0xC3C6)	1995.2(0x4DF0)	1596.2(0x3E5A)
Rx Power(µW)		126.1 (0x04ED)	63 (0x0276)	1.0 (0x000A)	0.56 (0x0005)

## Timing Diagram

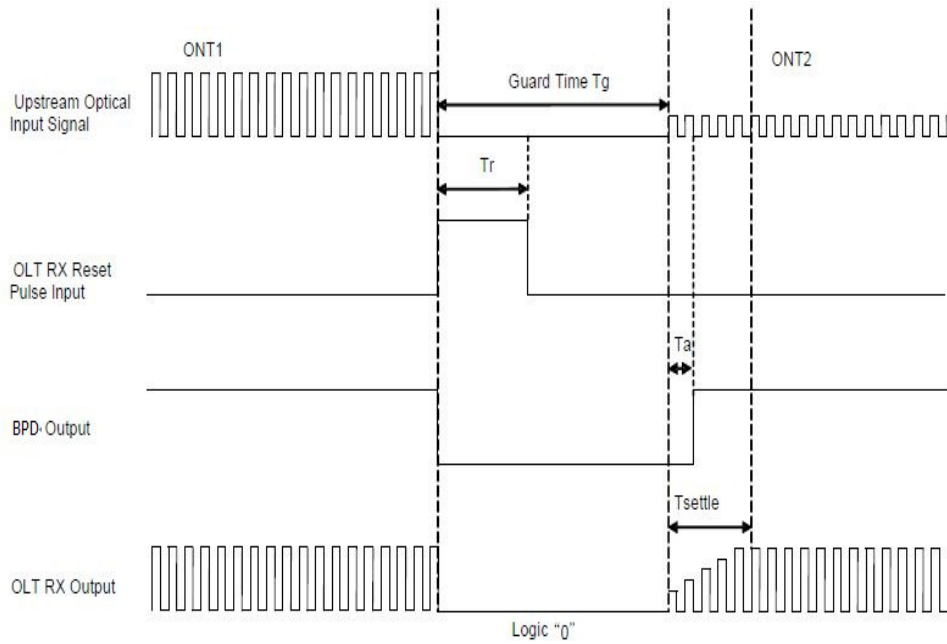

Time Parameter definition in GPON system

Parameter	Symbol	Min	Typ	Max	Unit	Remarks
Guard Time	T <sub>g</sub>	4			byte	
Reset Pulse Width	T <sub>r</sub>	16			bit	1
Burst Signal Detect Assert	T <sub>a</sub>			10	ns	2
Burst Mode Receiver Setting Time	T <sub>settle</sub>			44	bit	

### Notes:

1. The RESET signal should occur in the GUARD BAND time slot and commence immediately at the end of the ONT signal.
2. The Rx BURST PACKET DETECT (BPD) asserts LOW when the RESET signal is applied; asserts HIGH when an incoming burst is detected and latches HIGH until the next RESET signal.



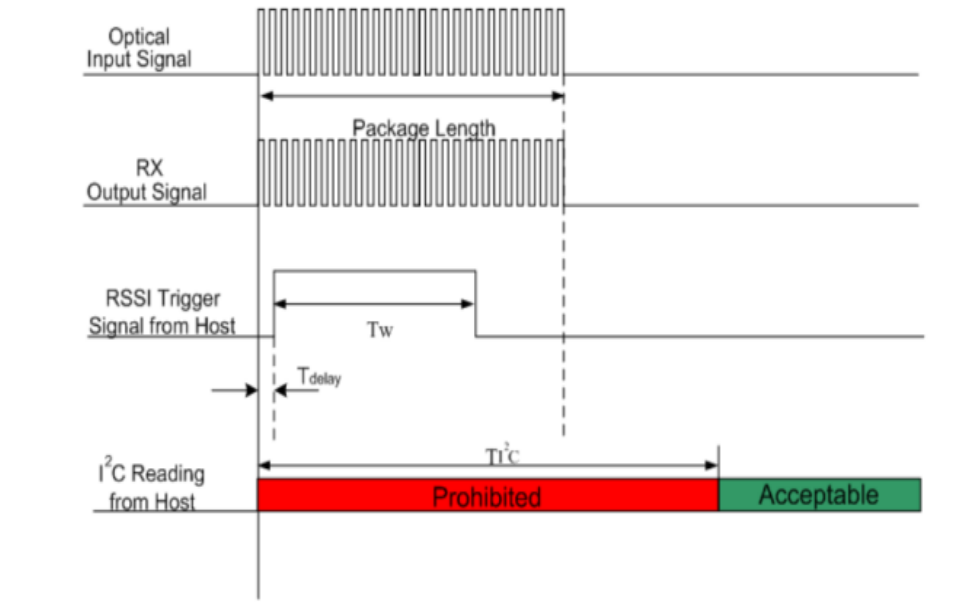

RSSI Timing Diagram

Parameter	Symbol	Min	Type	Max	Unit	Remarks
Trigger width	$T_w$	300			ns	
RSSI Trigger Delay	$T_{DELAY}$	30			ns	
I <sup>2</sup> C response time	$T_{I^2C}$			500	us	

## Dimensions

Module Weight: 20.5g

Dust Cap Weight: 0.95g

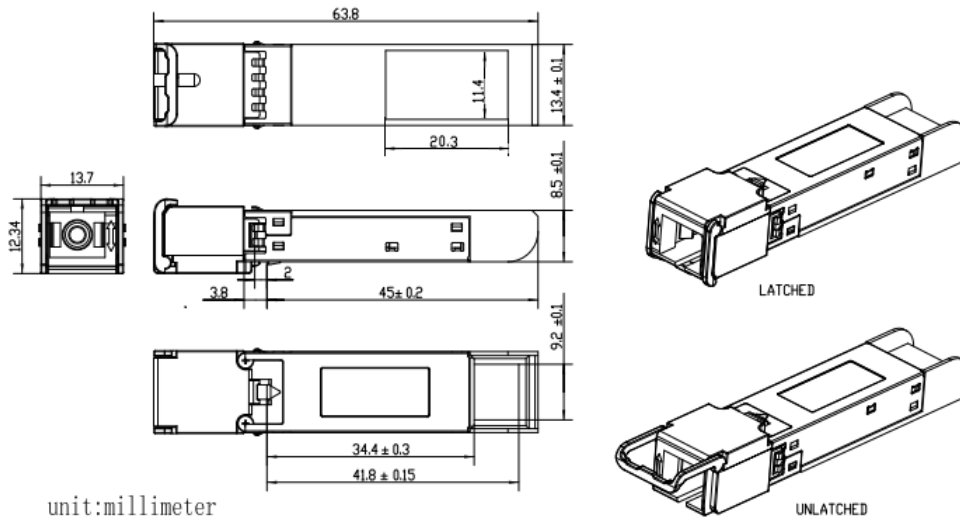

unit:millimeter

ALL DIMENSIONS ARE ±0.2mm UNLESS OTHERWISE SPECIFIED  
UNIT: mm

## Electrical Pad Layout

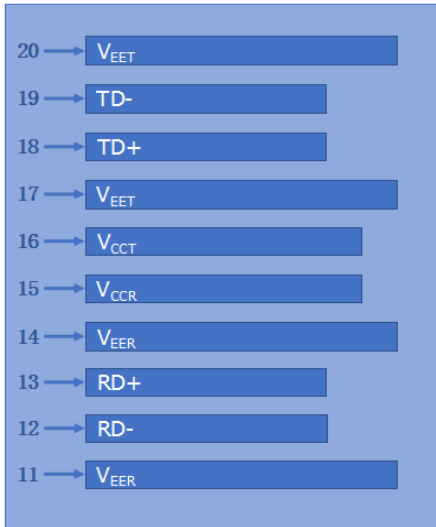

Top of Board

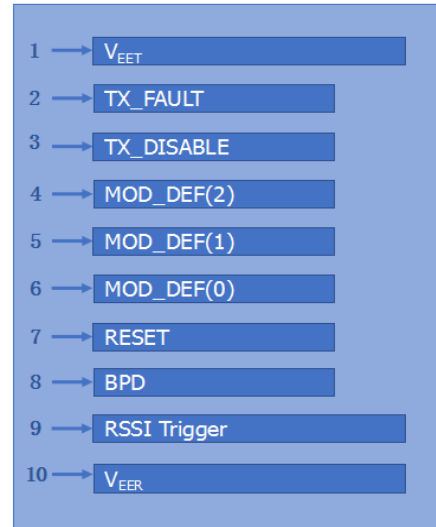
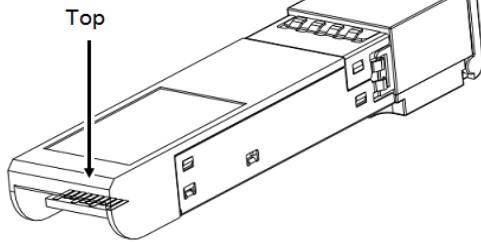

Bottom of Board

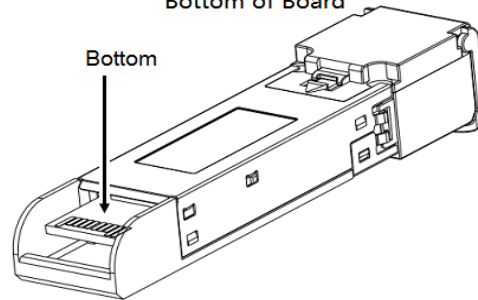

## Pin Assignment

PIN #	Symbol	Description	Remarks
1	V <sub>EET</sub>	Transmitter ground (common with receiver ground)	1
2	TX_FAULT	Transmitter Fault	
3	TX_DISABLE	Transmitter Disable. Laser output disabled on high or open	2
4	MOD_DEF(2)	Module Definition 2. Data line for serial ID	3
5	MOD_DEF(1)	Module Definition 1. Clock line for serial ID	3
6	MOD_DEF(0)	Module Definition 0. Grounded within the module	3
7	RESET	Receiver Reset	4
8	BPD	Burst Packet Detect	5
9	RSSI Trigger	RSSI Trigger Signal From Host	6
10	V <sub>EER</sub>	Receiver ground (common with transmitter ground)	1
11	V <sub>EER</sub>	Receiver ground (common with transmitter ground)	1
12	RD-	Receiver Inverted DATA out. AC coupled	
13	RD+	Receiver Non-inverted DATA out. AC coupled	
14	V <sub>EER</sub>	Receiver ground (common with transmitter ground)	1
15	V <sub>CCR</sub>	Receiver power supply	
16	V <sub>CCT</sub>	Transmitter power supply	
17	V <sub>EET</sub>	Transmitter ground (common with receiver ground)	1
18	TD+	Transmitter Non-Inverted DATA in. AC coupled	
19	TD-	Transmitter Inverted DATA in. AC coupled	
20	V <sub>EET</sub>	Transmitter ground (common with receiver ground)	1

### Notes:

1. Circuit ground is isolated from chassis ground
2. Disabled: T<sub>DIS</sub>>2V or open, Enabled: T<sub>DIS</sub><0.8V
3. Should Be pulled up with 4.7kΩ-10kΩ on host board to a voltage between 2V and 3.6V
4. Reset is a LVTTTL input which is used to clear receiver status before receiving the next burst packet
5. BPD is a LVTTTL output. High Level indicates that burst packet is detected by the receiver
6. RSSI Trigger is a LVTTTL input from host for starting ADC of digital RSSI circuit to sample the analog RSSI signal

### References

1. ITU-T G.984.2
2. Small Form Factor Pluggable (SFP) Transceiver Multi-Source Agreement (MSA), September 2000.
3. SFF-8472