

DATA SHEET

MODULETEK: SFP-OC3-BIDI-40KM-T1310R1550-x-D10

1.25Gb/s SFP (Small Form Pluggable) Tx1310nm/Rx1550nm Bi-directional Transceiver

Overview

ModuleTek's SFP-OC3-BIDI-40KM-T1310R1550-x-D10 SFP Bi-Directional transceiver is a high performance, cost effective module, which is Compliant with Specifications for IEEE 802.3. This module are designed for single fiber bidirectional data communication up to 40km. The digital diagnostics functions are available via the 2-wire serial bus, as specified in SFF-8472.

Product Features

- Supports data rates of 155Mb/s
- Hot-pluggable
- Built-in digital diagnostic functions
- 1310nm FP Laser transmitter
- Simplex LC connector
- Up to 40km on 9/125 μ m SMF
- Single power supply 3.3V
- RoHS Compliant
- Operating temperature range: Class C 0°C to 70°C
Class I -40°C to 85°C



Applications

- SDH STM-1/SONET OC-03

Ordering Information

Part Number	Product ID	Description	Color on Clasp
SFP-OC3-BIDI-40KM-T1310R1550-C-D10	M601201	GE/FC, SFP-BIDI, Single LC Connector, Tx1310nm/Rx1550nm, 40km,with DOMfunction.	Blue
SFP-OC3-BIDI-40KM-T155R1310-I-D10	M601202	GE/FC, SFP-BIDI, Single LC Connector, Tx1310nm/Rx1550nm, 40km,with DOMfunction.	Blue
For More Information: ModuleTek Limited Web: www.moduletek.com Email: sales@moduletek.com			

General Specifications

Parameter	Symbol	Min	Typ	Max	Unit	Remarks
Data Rate	DR		155		Mb/s	1
Bit Error Rate	BER			10^{-12}		
Operating Temperature	T_C	0		70	°C	2
		-40		85	°C	2
Storage Temperature	T_{STO}	-40		85	°C	3
Supply Current	I_{CC}			300	mA	4
Input Voltage	V_{CC}	3.14	3.3	3.46	V	
Maximum Voltage	V_{MAX}	-0.5		4	V	4

Notes:

1. IEEE 802.3
2. Case temperature
3. Ambient temperature
4. For electrical power interface

Transmission distance

Data Rate	Optical Fiber type	Distance range (km)	Remark
155Mb/s	9/125um Singel mode fiber	40	

Optical – Characteristics – Transmitter

$V_{CC}=3.14V$ to $3.46V$, T_C

Parameter	Symbol	Min	Typ	Max	Unit	Remarks
Output Optical Power	P_{TX}	-7		-2	dBm	1
Optical Center Wavelength	λ_C	1300	1310	1320	nm	
Extinction Ratio	ER	9.2			dB	
Spectral Width (RMS)	$\Delta\lambda$			3	nm	
Optical Rise/Fall Time (20%-80%)	t_r/t_f		150	260	ps	

Notes:

1. Class 1 Product

Optical – Characteristics – Receiver

$V_{CC}=3.14V$ to $3.46V$, T_C

Parameter	Symbol	Min	Typ	Max	Unit	Remarks
Receiver Overload	P_{OL}	0			dBm	
Optical Center Wavelength	λ_C	1480	1550	1580	nm	
Receiver Sensitivity	R_{X_SEN}			-32	dBm	
Optical Return Loss	ORL	12			dB	
LOS Assert	LOS_A	-45			dBm	
LOS De-Assert	LOS_D			-32	dBm	
LOS Hysteresis	LOS_H		2	2.5	dB	

Electrical – Characteristics – Transmitter

$V_{CC}=3.14V$ to $3.46V$, T_C

Parameter	Symbol	Min	Typ	Max	Unit	Remarks
Input differential impedance	R_{IN}		100		Ω	
Single ended data input swing	V_{IN_PP}	250		1200	mV	
Transmit disable voltage	V_D	$V_{CC}-1.3$		V_{CC}	V	
Transmit enable voltage	V_{EN}	V_{EE}		$V_{EE}+0.8$	V	
Transmit disable assert time				10	μs	

Electrical – Characteristics – Receiver

$V_{CC}=3.14V$ to $3.46V$, T_C

Parameter	Symbol	Min	Typ	Max	Unit	Remarks
Single ended data output swing	V_{OUT_PP}	300		800	mV	
Data output rise/fall time (20%-80%)	t_r/t_f			500	ps	
LOS Fault	V_{LOS_A}	$V_{CC}-0.5$		V_{CC_HOST}	V	
LOS Normal	V_{LOS_D}	V_{EE}		$V_{EE}+0.5$	V	

A0H Device register description

IIC Site	Byte size	Register name	Register description	Value(HEX)
0	1	Identifier	SFP	03
1	1	Extended Identifier	Use the IIC interface	04
2	1	Connector	Use the LC connector	07
3-10	8	Transceiver	100 Base-BX	00 10 02 00 00 00 00 00
11	1	Encoding	NRZ	03
12	1	BR, Nominal	155Mb/s nominal rate	02
13	1	Rate Identifier	No rate selection	00
14	1	Length(9μm)-km	In single-mode fiber transmission 40km	28
15	1	Length (9μm)-100m	In single-mode fiber transmission 40km	FF
16	1	Length (50μm)-10m	The transmission distance in the multimode fiber	00
17	1	Length (62.5μm)-10m	The transmission distance in the multimode fiber	00
18	1	Length (Copper)	The transmission distance over the copper cable	00
19	1	Reserved	Undefined	00
20-35	16	Trade name	MODULETEK	ASCII Format
36	1	Transceiver	Undefined	00
37-39	3	Vendor OUI	Vendor IEEE company ID	00 00 00
40-55	16	Vendor PN	Vendor's product model	Vendor defined
56-59	4	Vendor Revision Number	Vendor's product version number	Vendor defined
60-61	2	Wavelength	The laser has a wavelength of 1310 nanometers	05 1E
62	1	Reserved	Undefined	00
63	1	CC_BASE	0-62 Check and of bytes	Vendor defined
64-65	2	Transceiver Options	1.Rx_LOS Sigal monitoring 2.Tx_FAULT Sigal monitoring 3.Tx_DIS Sigal monitoring	00 1A
66	1	BR, max	High bit rate margin	00
67	1	BR, min	Low bit rate margin	00
68-83	16	Vendor SN	Vendor serial number	Vendor defined
84-91	8	Date code	The date code	Vendor defined
92	1	Monitoring Type	DOM Information internal calibration The received light power is measured using the average light power	68

93	1	Enhanced Options	1. Emitting light and receiving light alarm and warning monitoring 2. Tx_DIS Signal monitoring and control 3. Rx_LOS Signal monitoring 4. Tx_FAULT Signal monitoring	F0
94	1	Compliance	As defined in SFF-8472 in version 12.0	08
95	1	CC_EXT	64-94 Check and bytes	Vendor defined
96-127	32	Vendor Specific	Vendor custom areas	Vendor defined
128-255	128	Vendor Specific	Vendor custom areas	Vendor defined

Digital Diagnostic Functions

SFP-OC3-BIDI-40KM-T1310R1550-x-D10 supports the 2-wire serial communication protocol as defined in SFP MSA . Digital diagnostic information is accessible over the 2-wire interface at the address 0xA2. Digital diagnostics for SFP-OC3-BIDI-40KM-T1310R1550-x-D10 are internally calibrated by default. The internal micro control unit accesses the device operating parameters in real time, Such as transceiver temperature, laser bias current, transmitted optical power, received optical power and transceiver supply voltage. The module implements the alarm function of the SFP MSA , alerts the user when a particular operating parameter exceeds the factory-set normal range.

DDM Threshold Information

Parameter		Alarm Threshold		Warning Threshold	
		High Value	Low Value	High Value	Low Value
Temperature (°C)	C	75 (4B 00)	-5 (FB 00)	70 (46 00)	0(00 00)
	I	90 (5A 00)	-45 (D3 00)	85 (55 00)	-40 (D8 00)
Voltage (V)		3.63(8D CC)	2.97 (74 04)	3.46 (87 28)	3.13 (7A 44)
Bias Current (mA)		100 (C3 50)	2 (03 E8)	80 (9C 40)	4 (07 D0)
Tx Power (dBm)		-1.21 (1D 93)	-7.97 (06 3C)	-2.00 (18 A5)	-7 (07 CB)
Rx Power (dBm)		3.01 (4E 20)	-40 (00 01)	0.00 (27 10)	-35.23 (00 03)

Block-Diagram-of-Transceiver

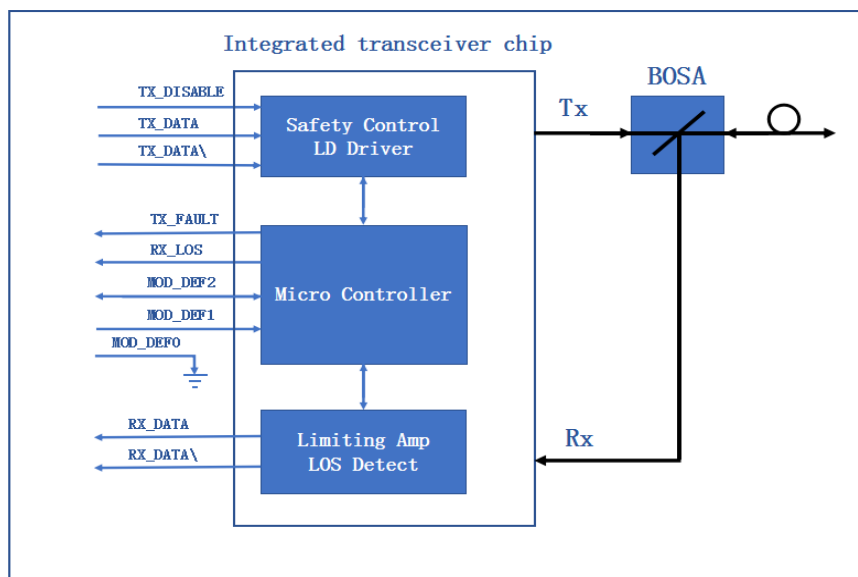

Functions Description

The transmitter is mainly composed of a laser driver part of the intelligent transceiver chip and a TOSA (light-emitting component), the TOSA includes a 1550nm DFB laser and a backlight photodetection chip. When the module is working, the input signal is connected to the intelligent transceiver chip, at this time, the laser driver of the intelligent transceiver chip supplies the bias current and the modulation current to the laser. The intelligent transceiver chip simultaneously uses an automatic optical power control (APC) feedback loop to maintain a constant average optical power of the laser output. The purpose is to eliminate the change of the output optical signal due to temperature changes and aging of the light source device. When the transmitter enable pin (TX_Disable) is high (TTL logic "1"), the laser output is turned off. When TX_Disable is low (TTL logic "0"), the laser will turn on within 1ms. When the transmitter fault signal (TX_Fault) is reported as high, indicates a transmitter failure caused by the transmitter's bias current or transmitted optical power or laser tube temperature exceeding a preset alarm threshold. Low indicates normal operation.

The receiver is mainly composed of a limiting amplifier part of the intelligent transceiver chip and a ROSA (light-receiving component), the ROSA includes a PIN photodetector and a transimpedance amplifier chip. When the ROSA detects the incident light signal, it will be converted into a photo-generated current by the PIN photodetector. The photo-generated current is converted into an electrical signal after passing through the transimpedance amplifier. The electrical signal is further amplified by the limiting amplifier of the intelligent transceiver chip, then outputs a fixed-amplitude electrical signal to the host. When the amplitude of the electrical signal received from the incident light conversion of the opposite optical transceiver module is lower than the set threshold, the module reports that the received signal is lost, the RX_LOS pin is high (logic "1"), which can be used to diagnose whether the physical signal is normal. The signal is operated in TTL level. The microprocessor inside the module monitors the module's operating voltage, temperature, transmitted optical power, received optical power, and laser bias current value in real time. The host acquires this information over a 2-wire serial bus.

The security level 2 password of this module is 0x12345678, method to enter safety level 2 operating status: Write the security level 2 password successvely in the refister 7B 7E of module A2H, namely 0x12、0x34、0x56、0x78; After entering safety level 2 working state, writes to registers other than A0H_LOW、A2H_T00、A2H_T01, the module may not work and need to be returned to the factory for repair.

Product weight

The module of weight: 18.5 Grams of each

Dust cap weight: 0.65 Grams of each

Dimensions

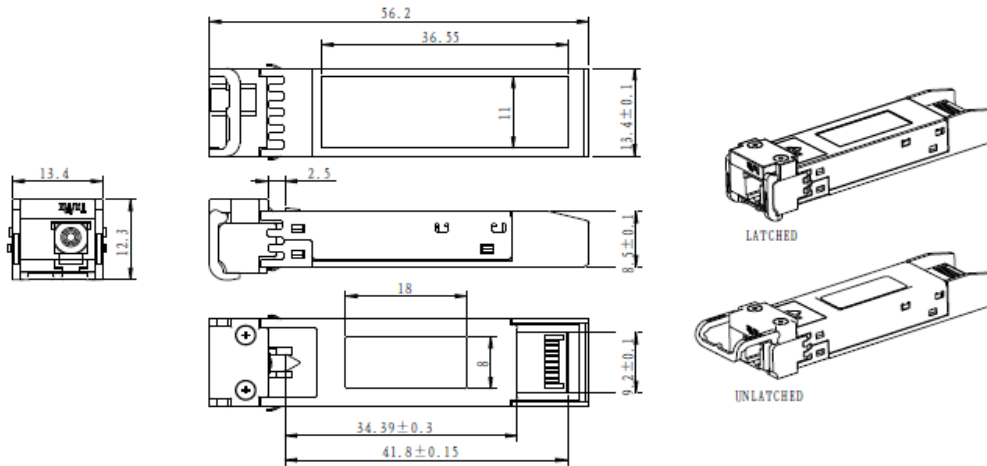

ALL DIMENSIONS ARE ± 0.2 mm UNLESS OTHERWISE SPECIFIED
UNIT: mm

Electrical Pad Layout

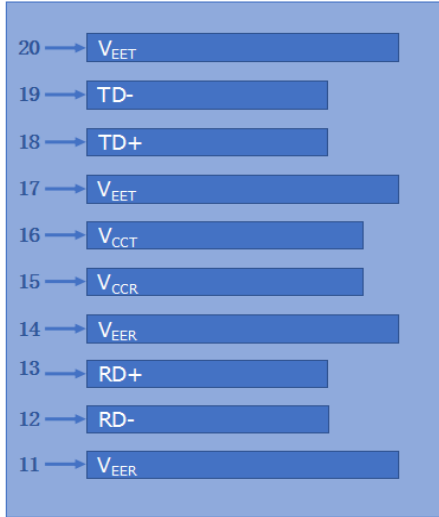

Top of Board

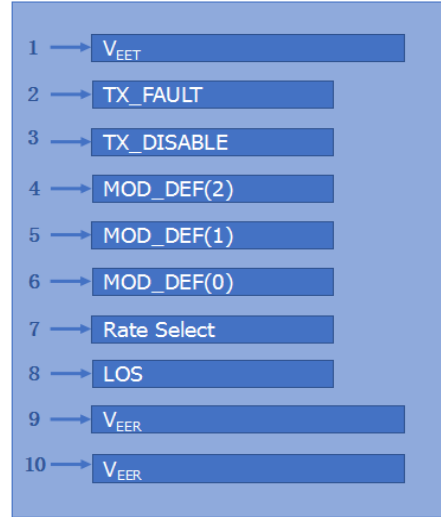

Bottom of Board

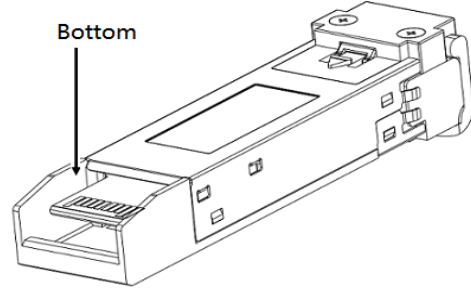
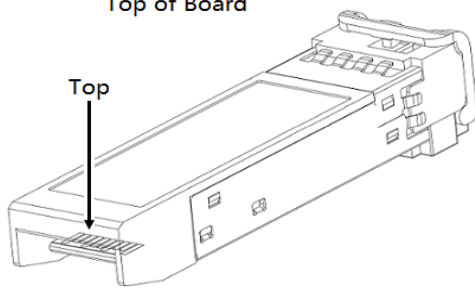

Typical Eye Diagram

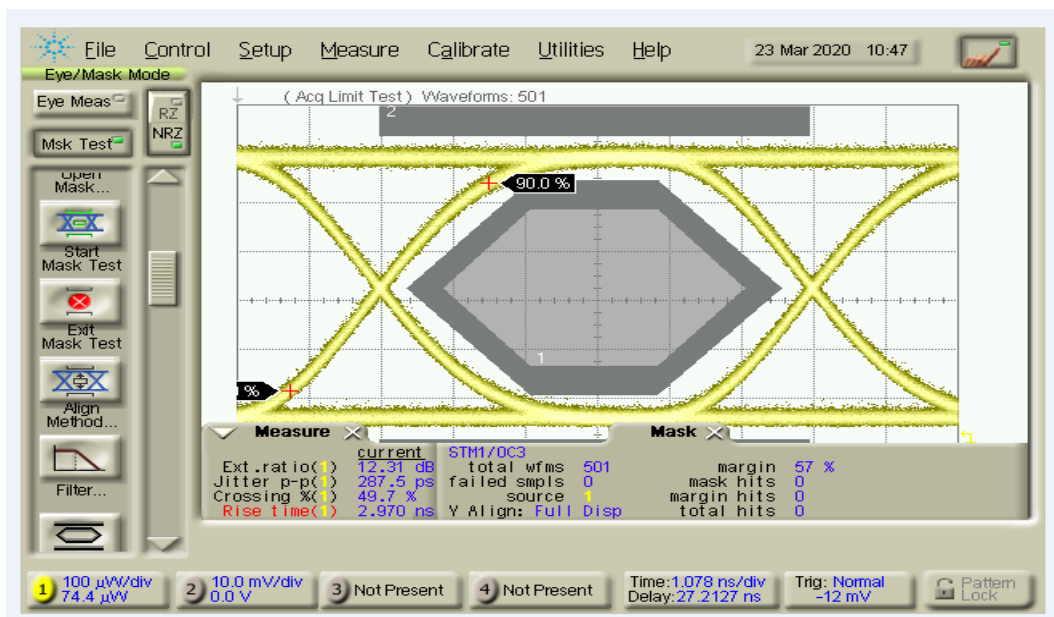

Pin Assignment

PIN #	Symbol	Description	Remarks
1	V _{EET}	Transmitter ground (common with receiver ground)	1
2	TX_FAULT	Transmitter Fault. Not supported	
3	TX_DISABLE	Transmitter Disable. Laser output disabled on high or open	2
4	MOD_DEF(2)	Module Definition 2. Data line for serial ID	3
5	MOD_DEF(1)	Module Definition 1. Clock line for serial ID	3
6	MOD_DEF(0)	Module Definition 0. Grounded within the module	3
7	Rate Select	No connection required	
8	LOS	Loss of Signal indication. Logic 0 indicates normal operation	4
9	V _{EER}	Receiver ground (common with transmitter ground)	1
10	V _{EER}	Receiver ground (common with transmitter ground)	1
11	V _{EER}	Receiver ground (common with transmitter ground)	1
12	RD-	Receiver Inverted DATA out. AC coupled	
13	RD+	Receiver Non-inverted DATA out. AC coupled	
14	V _{EER}	Receiver ground (common with transmitter ground)	1
15	V _{CCR}	Receiver power supply	
16	V _{CCT}	Transmitter power supply	
17	V _{EET}	Transmitter ground (common with receiver ground)	1
18	TD+	Transmitter Non-Inverted DATA in. AC coupled	
19	TD-	Transmitter Inverted DATA in. AC coupled	
20	V _{EET}	Transmitter ground (common with receiver ground)	1

Notes:

1. Circuit ground is isolated from chassis ground
2. Disabled: T_{DIS} > 2V or open, Enabled: T_{DIS} < 0.8V
3. Should Be pulled up with 4.7k – 10k ohm on host board to a voltage between 2V and 3.6V
4. LOS is open collector output

References

1. IEEE standard 802.3. IEEE Standard Department, 2005.
2. Small Form Factor Pluggable (SFP) Transceiver Multi-Source Agreement (MSA), September 2000.
3. Digital Diagnostics Monitoring Interface for Optical Transceivers – SFF-8472.