

## DATA SHEET

### MODULETEK: SFP10-LR-10KM-x-D10

10Gb/s SFP+ LR Transceiver

### SFP10-LR-10KM-x-D10 Overview

ModuleTek's SFP10-LR-10KM-x-D10 SFP+ optical transceivers are based on 10G Ethernet IEEE 802.3ae standard and SFF-8431 standard, providing a fast and reliable interface for 10G Ethernet applications. The product implements digital diagnostics via a 2-wire serial bus ,compliant with the SFF-8472 standard.

### Product Features

- Supports from 9.83Gb/s to 11.3Gb/s bit rates
- Compliant with IEEE 802.3ae 10GBASE-LR/LW
- Compliant with 10G FC 1200-SM-LL-L
- Compliant with SFF-8431
- Hot-pluggable SFP+ footprint
- 1310nm DFB laser transmitter
- Duplex LC connector
- Built-in digital diagnostic functions
- Up to 10km on SMF
- Single power supply 3.3V
- RoHS Compliant
- Operating temperature range (Case Temperature): C Grade 0°C to 70°C  
I Grade -40°C to 85°C



### Applications

- 10GBASE-LR/LW Ethernet
- 10G Fibre Channel
- 10G CPRI

## Ordering Information

Part Number	Product ID	Description	Color on Clasp
SFP10-LR-10KM-C-D10	M444201	10GBASE-LR SFP+ 1310nm LC Connectors 10km on SMF, Commercial Temperature.	Blue
SFP10-LR-10KM-I-D10	M333601	10GBASE-LR SFP+ 1310nm LC Connectors 10km on SMF, Industrial Temperature.	Blue
<b>Notes:</b> 1.Product ID is the abbreviated order number of the standard model of our products			
<b>For More Information:</b> ModuleTek Limited Web: <a href="http://www.moduletek.com">www.moduletek.com</a> Email: <a href="mailto:sales@moduletek.com">sales@moduletek.com</a>			

## General Specifications

Parameter	Symbol	Min	Typ	Max	Unit	Remarks
Data Rate	DR	9.83	10.3125	11.3	Gb/s	1
Bit Error Rate	BER			$10^{-12}$		
Operating Temperature	$T_C$	0		70	°C	2
		-40		85	°C	2
Storage Temperature	$T_{STO}$	-40		85	°C	3
Supply Current	$I_{CC}$		200	285	mA	4
Input Voltage	$V_{CC}$	3.14	3.3	3.46	V	
Maximum Voltage	$V_{MAX}$	-0.5		4	V	4

**Notes:**

1. IEEE 802.3ae
2. Case temperature
3. Ambient temperature
4. For electrical power interface

## Link Distances

Data Rate	Fiber Type	Distance Range (km)
9.83 – 11.3 Gb/s	9/125umSMF	10

## Optical – Characteristics – Transmitter

$V_{CC}=3.14V$  to  $3.46V$ ,  $T_C$

Parameter	Symbol	Min	Typ	Max	Unit	Remarks
Output Optical Power	$P_{TX}$	-8.2		0.5	dBm	1
Optical Center Wavelength	$\lambda_C$	1260		1355	nm	
Optical Modulation Amplitude	OMA	-5.2			dBm	2
Extinction Ratio	ER	3.5	5.5		dB	
Spectral Width(-20dB)	$\Delta\lambda$			1	nm	
Side Mode Suppression Ratio	SMSR	30			dB	
Relative Intensity Noise	RIN			-128	dB/Hz	
Transmitter Dispersion Penalty	TDP			3.2	dB	
Launch Power of OFF Transmitter	$P_{OUT\_OFF}$			-30	dBm	1
Transmitter Jitter						2

**Notes:**

1. Average
2. According to IEEE 802.3ae requirement

## Optical – Characteristics – Receiver

$V_{CC}=3.14V$  to  $3.46V$ ,  $T_C$

Parameter	Symbol	Min	Typ	Max	Unit	Remarks
Optical Center Wavelength	$\lambda_C$	1260		1600	nm	
Average Receive Power	$P_{RX}$	-14.4		0.5	dBm	
Receiver Sensitivity @10.3Gb/s	$R_{X\_SEN}$			-14.4	dBm	1
Receiver Reflectance	$TR_{RX}$			-12	dB	
LOS Assert	$LOS_A$	-30			dBm	
LOS De-Assert	$LOS_D$			-17	dBm	
LOS Hysteresis	$LOS_H$	0.5			dB	

**Notes:**

1. Test the resulting value using the minimum ER value within the defined range;  $BER < 10^{-12}, 2^{31} - 1$  PRBS

## Electrical – Characteristics – Transmitter

$V_{CC}=3.14V$  to  $3.46V$ ,  $T_C$

Parameter	Symbol	Min	Typ	Max	Unit	Remarks
Input differential impedance	$R_{IN}$		100		$\Omega$	
Differential data input swing	$V_{IN\_PP}$	180		700	mV	
Transmit disable voltage	$V_D$	2		$V_{CC}$	V	
Transmit enable voltage	$V_{EN}$	$V_{EE}$		$V_{EE}+0.8$	V	

## Electrical – Characteristics – Receiver

$V_{CC}=3.14V$  to  $3.46V$ ,  $T_C$

Parameter	Symbol	Min	Typ	Max	Unit	Remarks
Differential data output swing	$V_{OUT\_PP}$	300		850	mV	
Data output rise/fall time (20%-80%)	$t_r/t_f$	28			ps	
LOS Assert	$V_{LOS\_A}$	2		$V_{CC\_HOST}$	V	
LOS De-Assert	$V_{LOS\_D}$	$V_{EE}$		$V_{EE}+0.5$	V	

## A0H Register Description

IIC Addr	Size	Name	Description	Values(HEX)
0	1	Identifier	SFP/SFP+/SFP28	03
1	1	Extended Identifier	Use IIC interface	04
2	1	Connector	Connector Type = LC	07
3-10	8	Transceiver	10G Base LR	20 00 00 00 00 00 00 00
11	1	Encoding	Encoding Type = 64B/66B	06
12	1	BR, Nominal	Nominal Bit Rate 10.3Gb/s	67
13	1	Rate Identifier	Without rate selection function	00
14	1	Length(9µm)-km	Link Length / SMF = 10km	0A
15	1	Length (9µm)-100m	Link Length / SMF = 10km	64
16	1	Length (50µm)-10m	50µm MMF Link Length = N/A	00
17	1	Length (62.5µm)-10m	62.5µm MMF Link Length = N/A	00
18	1	Length (Copper)	Copper Link Length = N/A	00
19	1	Reserved	Reserved	00
20-35	16	Vendor name	MODULETEK	4D 4F 44 55 4C 45 54 45 4B 20 20 20 20 20 20 20
36	1	Transceiver	Reserved	00
37-39	3	Vendor OUI	Without vendor OUI	00 00 00
40-55	16	Vendor PN	Part number in the Ordering Information	Programmed by Factory
56-59	4	Vendor Revision Number	Manufacturer product version number	Programmed by Factory
60-61	2	Wavelength	Laser Wavelength = 1310nm	05 1E
62	1	Reserved	Reserved	00
63	1	CC_BASE	Checksum of bytes 0-62	Programmed by Factory
64-65	2	Transceiver Options	1.Rx_LOS 2.Tx_FAULT 3.Tx_DIS	00 1A
66	1	BR, max	NA	00
67	1	BR, min	NA	00
68-83	16	Vendor SN	Manufacturer serial number	Programmed by Factory
84-91	8	Date code	Date code	Programmed by Factory
92	1	Monitoring Type	Internal calibration of DOM RxPower measurement using average optical power	68
93	1	Enhanced Options	1.Monitor Alarm and Warning of TxPower and RxPower 2.Tx_DIS Monitor and Control 3.Rx_LOS Monitor 4.Tx_FAULT Monitor	F0
94	1	Compliance	Revision Implemented	08
95	1	CC_EXT	Check sum of bytes 64-94	Programmed by Factory
96-127	32	Vendor Specific	Vendor Specific Area	Programmed by Factory
128-255	128	Vendor Specific	Vendor Specific Area	Programmed by Factory

## Digital Diagnostic Functions

SFP10-LR-10KM-x-D10 supports the 2-wire serial communication protocol as defined in SFF-8472. Digital diagnostic information is accessible over the 2-wire interface at the address 0xA2. Digital diagnostics for SFP10-LR-10KM-x-D10 are internally calibrated by default. The internal micro control unit accesses the device operating parameters in real time, Such as transceiver temperature, laser bias current, transmitted optical power, received optical power and transceiver supply voltage. The module implements the alarm function of the SFF-8472, alerts the user when a particular operating parameter exceeds the factory-set normal range.

## DDM Threshold Information

Parameter		Alarm Threshold		Warning Threshold	
		High Value	Low Value	High Value	Low Value
Temperature (°C)	C	90 (5A 00)	-10 (F6 00)	85 (55 00)	-5 (FB 00)
	I	90 (5A 00)	-45 (D3 00)	85 (55 00)	-40 (D8 00)
Vcc (V)		3.63(8D CC)	2.97 (74 04)	3.46 (87 28)	3.13 (7A 44)
Bias (mA)		100 (C3 50)	2 (03 E8)	80 (9C 40)	4 (07 D0)
TxPower (dBm)		1.3 (34 98)	-9.2 (04 BA)	0.5 (2B D4)	-8.2 (05 E9)
RxPower (dBm)		3.0 (4E 20)	-18.0 (00 9E)	0.0 (27 10)	-15.0 (01 3C)

## Block-Diagram-of-Transceiver

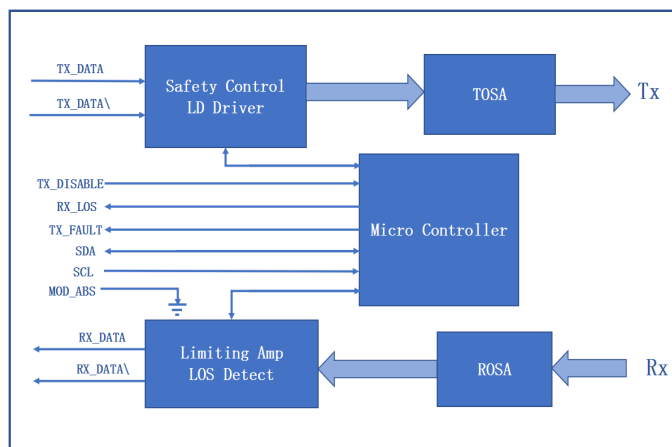

## Functions Description

The transmitter consists of a laser driver chip and a TOSA (light-emitting component), the TOSA includes a 1310nm DFB laser and a backlight photodetection chip. When the module is working, and the input signal is connected to the laser driver chip. The laser driver chip supplies the bias current and the modulation current to the laser. The laser driver chip simultaneously uses an automatic optical power control (APC) feedback loop to maintain a constant average optical power of the laser output. The purpose is to eliminate the change of the output optical signal due to temperature changes and aging of the light source device. When the transmitter enable pin (TX\_Disable) is high (TTL logic “1”), the laser output is turned off. When TX\_Disable is low (TTL logic “0”), the laser will turn on within 1ms. When the transmitter fault signal (TX\_Fault) is reported as high, indicates a transmitter failure caused by the transmitter’s bias current or transmitted optical power or laser tube temperature exceeding a preset alarm threshold. Low indicates normal operation.

There is no isolator at the transmitter and the anti-reflection capability will be deteriorated, which is related to the actual link fiber environment.

The receiver consists of a ROSA (light-receiving component) and a limiting amplifier chip, the ROSA includes a PIN photodetector and a transimpedance amplifier chip. When the ROSA detects the incident light signal, it will be converted into a photo-generated current by the PIN photodetector. The photo-generated current is converted into an electrical signal after passing through the transimpedance amplifier. The electrical signal is further amplified by the limiting amplifier, then outputs a fixed-amplitude electrical signal to the host. When the amplitude of the electrical signal received from the incident light conversion of the opposite optical transceiver module is lower than the set threshold, the module reports that the received signal is lost, the RX\_LOS pin is high (logic “1”), which can be used to diagnose whether the physical signal is normal. The signal is operated in TTL level. The microprocessor inside the module monitors the module’s operating voltage, temperature, transmitted optical power, received optical power, and laser bias current value in real time. The host acquires this information over a 2-wire serial bus.

After the module is powered on, the read value of the security level access registers 7BH ~ 7EH of A2H is replaced with 0x00. After the content of this group of registers is updated, the read value is

the last written value. The security level 1 password of this module is 0x00000000. The method to enter the security level 1 working state is to convert and write the security level 1 password in the A2H 7BH ~ 7EH registers of the module, namely 0x00, 0x00, 0x00, 0x00. After entering the security level 1 working state, the user can directly write to the contents of the A0H device address. This version does not support the user to write to the contents of Table 00 and Table 01 of A2H in the security level 1 state. And this version of the module does not support users to modify the security level 1 password.

## Product Weight

Net weight of module : 18.0g/pcs

Net weight of dust cap: 0.95g/pcs

## Dimensions

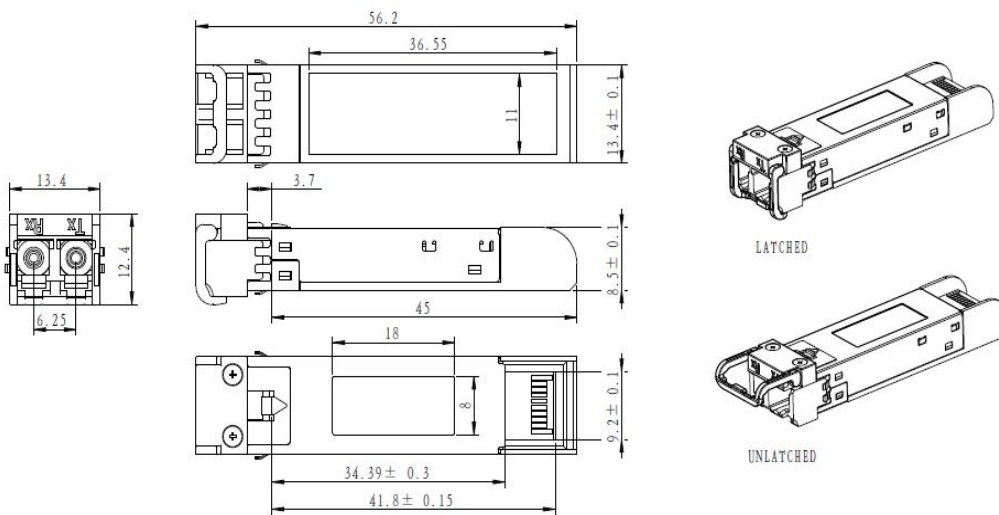

ALL DIMENSIONS ARE ±0.2mm UNLESS OTHERWISE SPECIFIED  
UNIT: mm



## Electrical Pad Layout

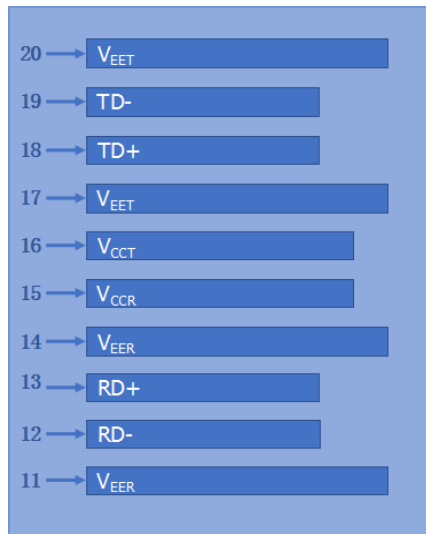

Top of Board

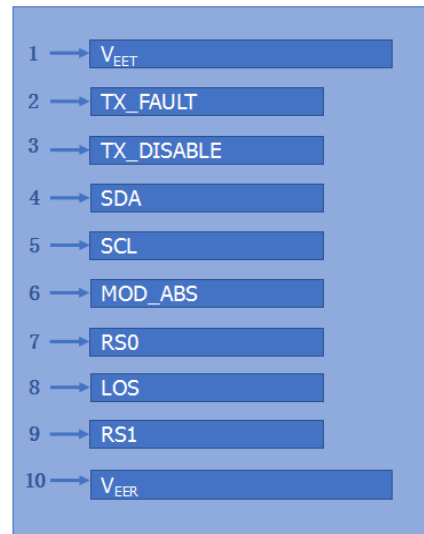

Bottom of Board

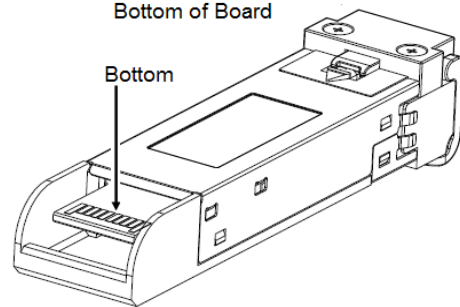
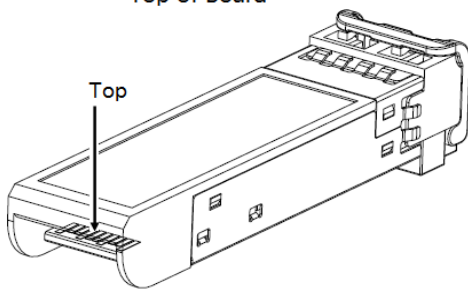

## Typical Eye Diagram

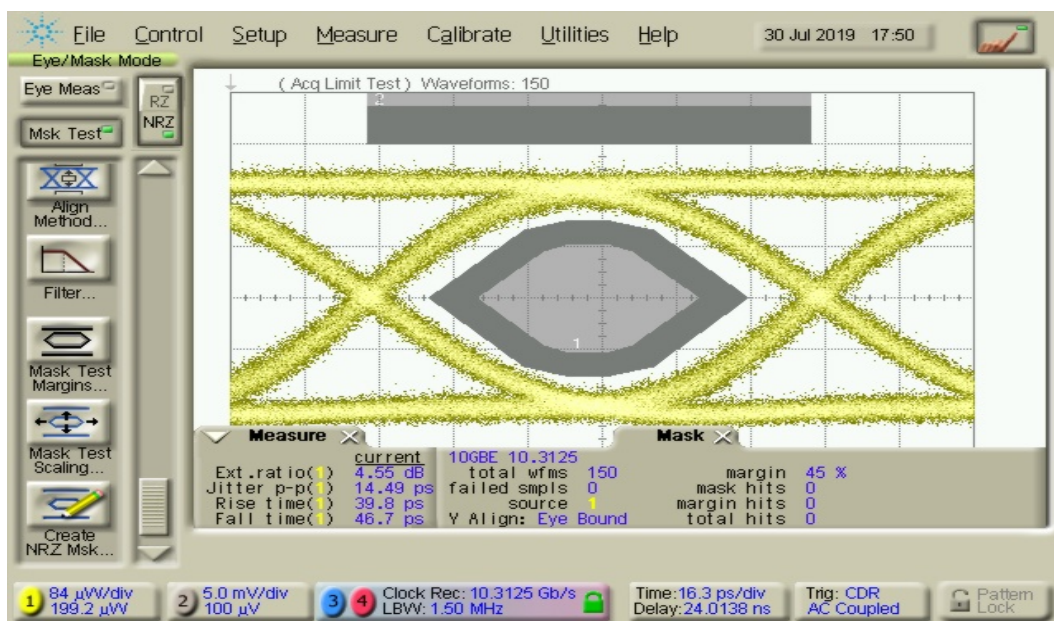

## Pin Assignment

PIN #	Symbol	Description	Remarks
1	V <sub>EET</sub>	Transmitter ground (common with receiver ground)	1
2	TX_FAULT	Transmitter Fault	2
3	TX_DISABLE	Transmitter Disable. Laser output disabled on high or open	3
4	SDA	2-wire Serial Interface Data Line	4
5	SCL	2-wire Serial Interface Clock Line	4
6	MOD_ABS	Module Absent. Grounded within the module	4
7	RS0	No connection required	
8	LOS	Loss of Signal indication. Logic 0 indicates normal operation	5
9	RS1	No connection required	1
10	V <sub>EER</sub>	Receiver ground (common with transmitter ground)	1
11	V <sub>EER</sub>	Receiver ground (common with transmitter ground)	1
12	RD-	Receiver Inverted DATA out. AC coupled	
13	RD+	Receiver Non-inverted DATA out. AC coupled	
14	V <sub>EER</sub>	Receiver ground (common with transmitter ground)	1
15	V <sub>CCR</sub>	Receiver power supply	
16	V <sub>CCT</sub>	Transmitter power supply	
17	V <sub>EET</sub>	Transmitter ground (common with receiver ground)	1
18	TD+	Transmitter Non-Inverted DATA in. AC coupled	
19	TD-	Transmitter Inverted DATA in. AC coupled	
20	V <sub>EET</sub>	Transmitter ground (common with receiver ground)	1

### Notes:

1. Circuit ground is isolated from chassis ground
2. TX\_FAULT is the open collector output and should be pulled up with 4.7k–10k ohm on host board to a voltage between 2V and V<sub>cc</sub>+0.3V
3. Disabled: T<sub>DIS</sub>>2V or open, Enabled: T<sub>DIS</sub><0.8V
4. Should be pulled up with 4.7k –10k ohm on host board to a voltage between 2V and V<sub>cc</sub> + 0.3V
5. LOS is open collector output and should be pulled up with 4.7k –10k ohm on host board to a voltage between 2V and V<sub>cc</sub>0.3V, the logic "0" indicates normal operation, and the logic "1" indicates that the receiver signal is lost.

## References

1. IEEE standard 802.3ae. IEEE Standard Department, 2005.
2. Specification for SFP+ 10Gb/s and Low Speed Electrical Interface –SFF-8431.
3. Specification for Diagnostic Monitoring Interface for SFP+ - SFF-8472.